

PROKIT EP 200

The side protection for increased requirements

Product Brochure – Issue 12/2017

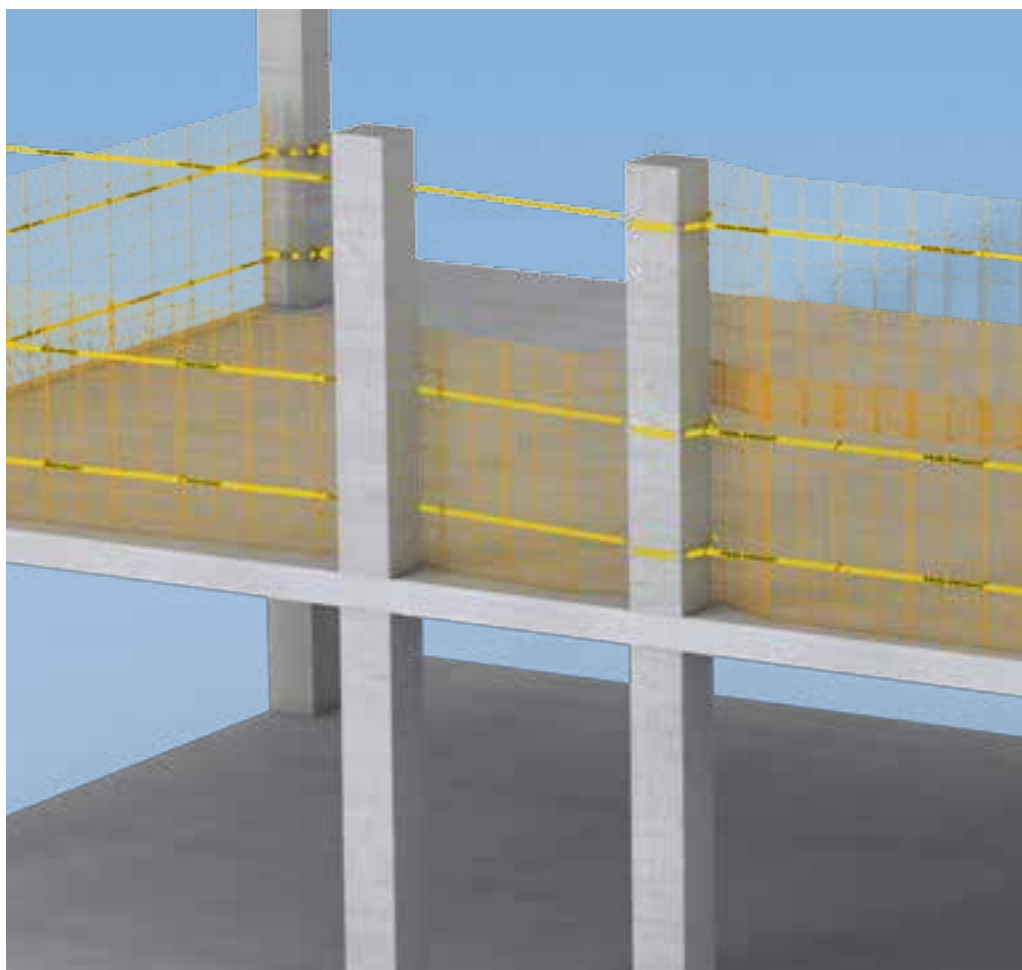

Content

- System advantages**
- 4 The side protection for increased requirements
 - 6 Fast assembly

- System supplements**
- 7 Practical system supplements

Issue 12/2017

Publisher

PERI GmbH
Formwork Scaffolding Engineering
Rudolf-Diesel-Strasse 19
89264 Weissenhorn
Germany
Tel. +49 (0)7309.950-0
Fax +49 (0)7309.951-0
info@peri.com
www.peri.com

Components

8 Components

Important information

All current safety regulations and guidelines applicable in those countries where our products are used must be observed.

The photos shown in this brochure feature construction sites in progress. For this reason, safety and anchor details in particular cannot always be considered as conclusive or final. These are subject to the risk assessment carried out by the contractor.

In addition, computer graphics are used which are to be understood as system representations. For ensuring a better understanding, these and the detailed illustrations shown have been partially

reduced to show certain aspects. The safety installations which have possibly not been shown in these detailed descriptions must nevertheless still be available. The systems or items shown might not be available in every country.

Safety instructions and load specifications are to be strictly observed at all times. Separate structural calculations are required for any deviations from the standard design data.

The information contained herein is subject to technical changes in the interests of progress. Errors and typographical mistakes reserved.

The side protection for increased requirements



PROKIT EP 200 protects site personnel during construction of building shells against falling. The system ensures safe working areas and access ways thus increasing safety levels of jobsite personnel as well as improving work efficiency. In addition, the 2.00 m high mesh barriers prevent material from falling off the edge of the building. With just a few individual components, PROKIT EP 200 can be assembled very quickly without any tools.

Assembly of the PROKIT EP 200 anti-fall protection is extremely simple: high-quality tension belts – securely connected between two supports – serve as a mounting support for the PROKIT Fold Mesh. The 2.00 m high,

close-meshed barriers are easily attached to the tension belts with cable ties. Mounting this anti-fall protection is thus carried out completely independent of the slab itself, and the concrete components remain undamaged.

The mesh barrier only weighs 7.5 kg and provides enhanced work ergonomics. The yellow powder coating increases the signal effect at the hazardous area; it is very durable and ensures a long life of the mesh screen.

If necessary, e.g. for inner-city construction sites, 2 screens can be arranged one on top of each other as a floor-to-slab enclosure. With additional netting, the PROKIT EP 200 can also be used as dust protection.

- **Reliable and safer protection** against falling from open edges on building shells (in accordance with DIN EN 13374, Class A).
- **Fast assembly** with only a minimum of lightweight individual components as well as easy to handle connecting means such as tension belts and cable ties.
- **Floor-to-ceiling enclosure** up to 3.90 m for optimal protection with increased requirements.
- **Slab-independent fixing** without any damage to the existing building structure

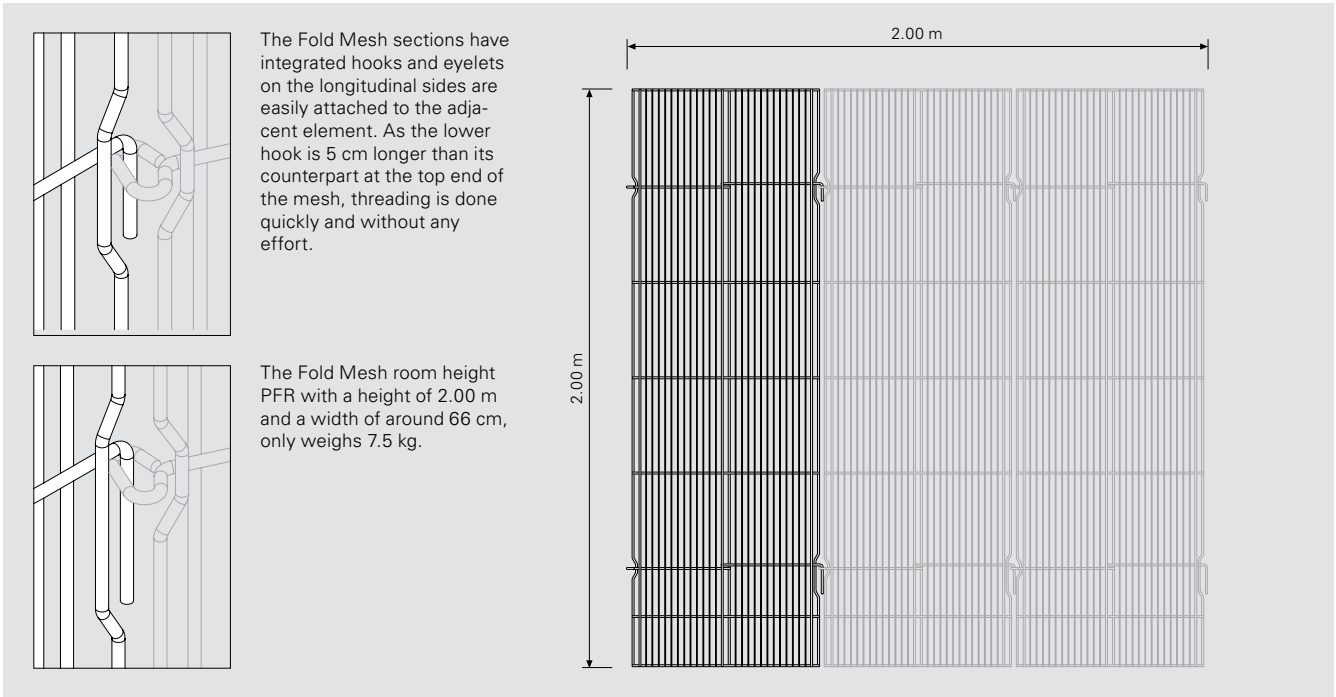

The Fold Mesh sections have integrated hooks and eyelets on the longitudinal sides are easily attached to the adjacent element. As the lower hook is 5 cm longer than its counterpart at the top end of the mesh, threading is done quickly and without any effort.

The Fold Mesh room height PFR with a height of 2.00 m and a width of around 66 cm, only weighs 7.5 kg.



The Tension Belt PTB 12 is tensioned between two supports and forms the sub-construction for the Fold Mesh PFR. The two-piece belt with a length of 12.00 m is equipped with hooks and securing straps.



The tension belts are pulled through the eyelets, the hooks are attached which closes the strap around the support.



Cable Ties PCT serve to attach the Fold Mesh to the Tension Belts. They are matched to the system and UV-resistant.



For preventing any damage to the support edges, a plastic hose is used which is pulled over the tension belt.

Fast assembly

Belt assembly in detail

The extremely tear-resistant belt is placed around the first support, then looped around the second column. The ratchet is used to tighten with around 5 kN to 6 kN preload force.

PROKIT Tension Belts are approved and tested according to EN 12195-2 and the corresponding label is sewn on the lashing strap.

If required, two meshes can also be mounted one on top of the other with the overall height then reaching up to 3.90 m. However, three tension belts are normally sufficient. If securing working operations means that the mesh is installed directly up to under the slab, four tension belts are to be used.



The fold mesh construction can easily be adjusted to suit wall offsets.



The mesh simply bypasses any columns positioned along the installation path.



The powder-coated mesh barrier can also be used as rear safety protection for climbing formwork.



Practical system supplements

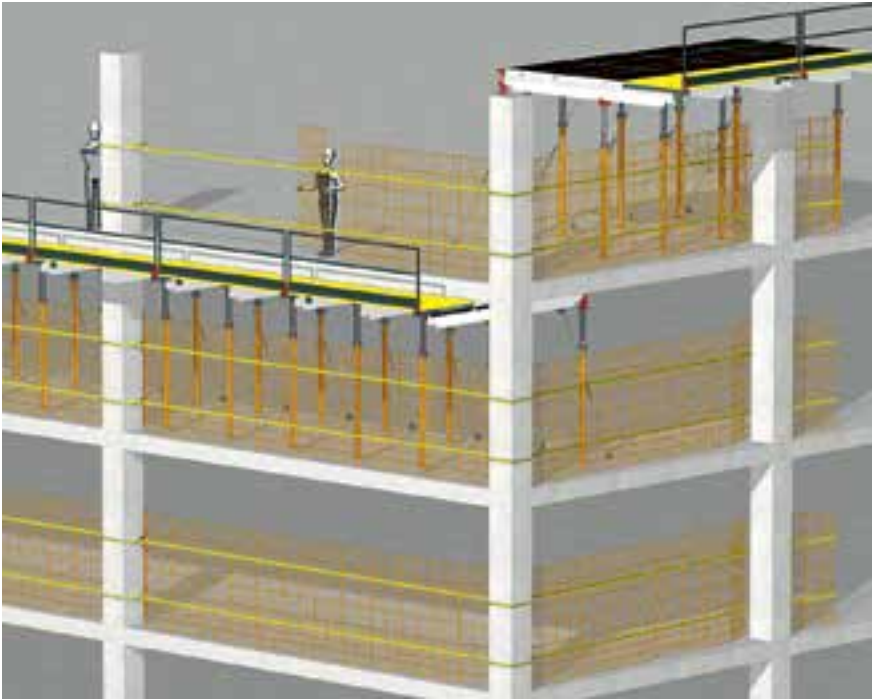

PERI PROKIT EP 200 is suitable in particular for use in high skeleton structures. The design of the 2.00 m high side protection gives site personnel a greater sense of security so that working efficiency at large heights is increased.

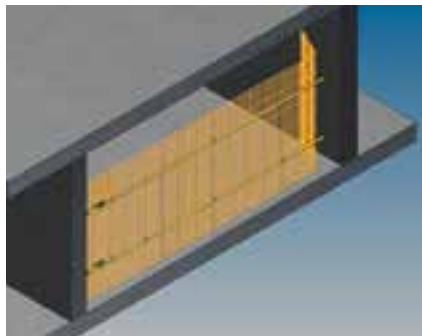
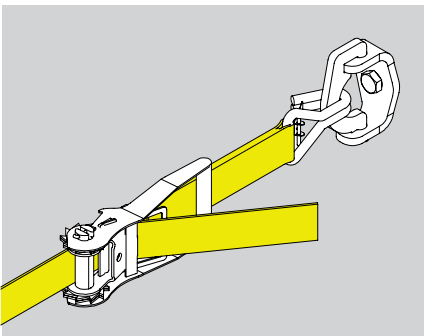

With the galvanized Wall Fixing PWF, the tension belts can be fixed to the rising walls.

Also on working platforms, the PROKIT Fold Mesh serves as 2.00 m high protection.



For easy handling and safe logistics, 45 meshes can be stacked and transported on one pallet.



Item no.	Weight kg
118350	7.690

Fold Mesh Room Height PFR
Need horizontal support.

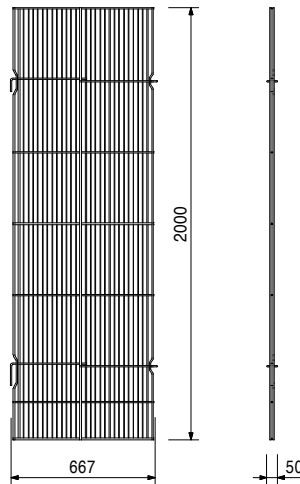
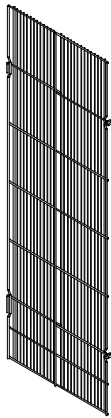

118349	3.530
--------	-------

Tension Belt PTB 12
Two parts.

Note
Consider information on the belt Label!
Technical Data
Total length 12 m, max. span 8 m.
Permissible tension force 2.5 t.

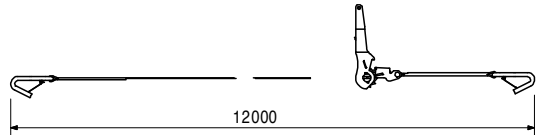
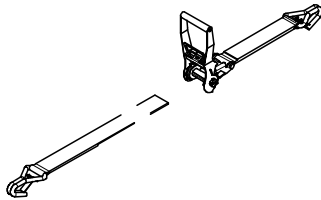

118408	0.006
--------	-------

Cable Tie PCT
For fixation of the barriers to the tension belts.

Technical Data
Black, uv-resistant.
Permissible load: 0.8 kN.

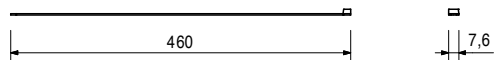
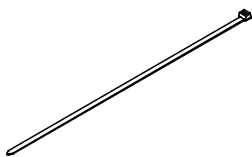

117200	0.244
--------	-------

Eyelet-2 PE
For easy interconnection of tension belts.

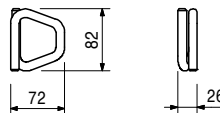

Item no.	Weight kg
118494	0.224

Edge Protector Hose PEH 1 m
To protect the edges and the tension belt.

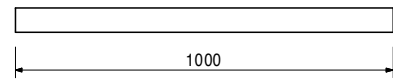
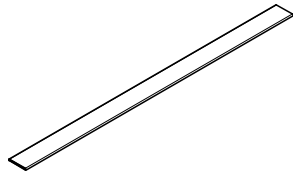

118493	0.137
--------	-------

Edge Protection Plate PEP
To protect the edges.

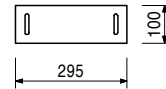
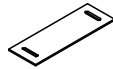

118405	0.918
--------	-------

Wall Fixing PWF
For attaching the tension belts to concrete walls.

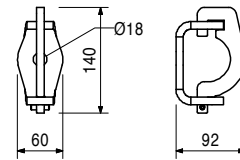

Accessories

117020	0.213
--------	-------

Anchor Bolt PERI 14 x 150

117020	0.213
--------	-------

Anchor Bolt PERI 14 x 150
Re-usable.
Approval available.

Note
Separate Design Information on request.

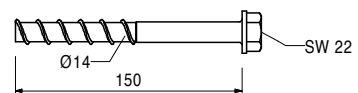
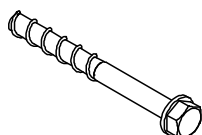

Item no.	Weight kg
035500	72.800

Stripping Cart, Alu

Mobile working scaffold. Height-adjustable in 25-cm-increments. Platform height max. 2.00 m.

Note

Follow Instructions for Use!

Technical Data

Permissible load 100 kg/m².

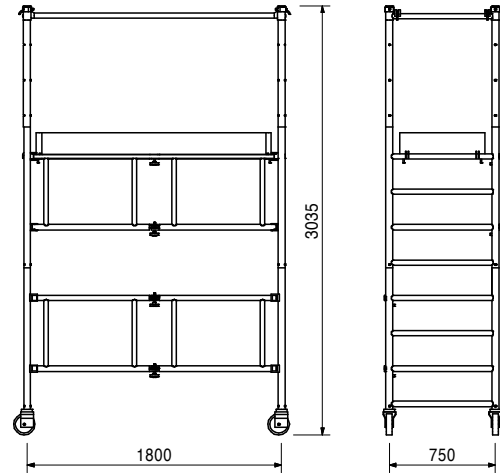
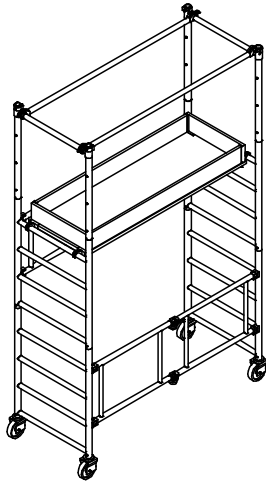

103434	38.500
--------	--------

Pallet RP-2 80 x 120, galv.

For stacking and transportation of formwork and scaffolding components.

Note

Follow Instructions for Use!

Technical Data

Permissible load-bearing capacity 1.5 t.

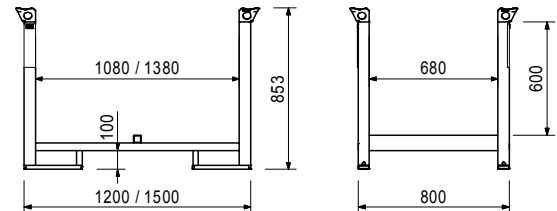
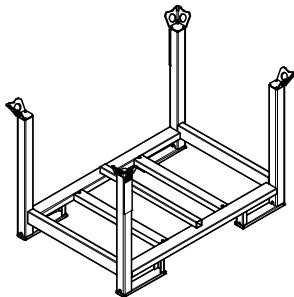

PERI International

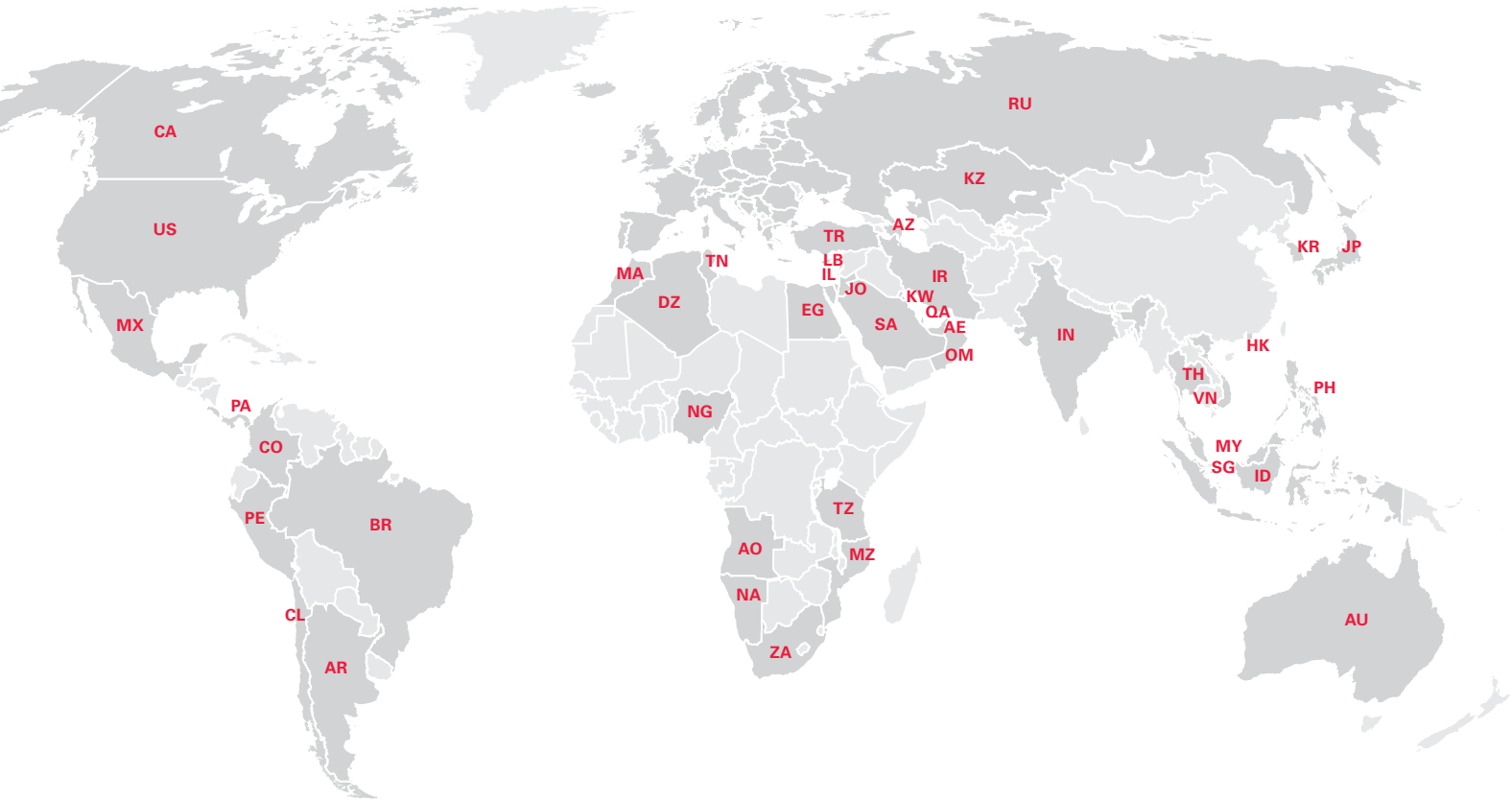

North America

- CA** Canada
PERI Formwork Systems, Inc.
www.peri.ca
- MX** Mexico
PERI Cimbras y Andamios, S.A. de C.V.
www.peri.com.mx
- PA** Panama
PERI Panama Inc.
www.peri.com.pa
- US** USA
PERI Formwork Systems, Inc.
www.peri-usa.com

South America

- AR** Argentina
PERI S.A.
www.peri.com.ar
- BR** Brazil
PERI Formas e Escoramentos Ltda.
www.peribrasil.com.br
- CL** Chile
PERI Chile Ltda.
www.peri.cl
- CO** Colombia
PERI S.A.S.
www.peri.com.co
- PE** Peru
PERI Peruana S.A.C.
www.peri.com.pe

Africa

- AO** Angola
Pericofragens, Lda.
www.peri.pt
- DZ** Algeria
S.A.R.L. PERI
www.peri.dz
- EG** Egypt
Egypt Branch Office
www.peri.com.eg
- MA** Morocco
PERI S.A.
www.peri.ma
- MZ** Mozambique
PERI (Pty.) Ltd.
www.peri.co.mz
- NA** Namibia
PERI (Pty.) Ltd.
www.peri.na
- NG** Nigeria
PERI Nigeria Ltd.
www.peri.ng
- TN** Tunisia
PERI S.A.U.
www.peri.es
- TZ** Tanzania
PERI Formwork and Scaffolding Ltd
www.peri.co.tz
- ZA** South Africa
PERI Formwork Scaffolding (Pty) Ltd
www.peri.co.za

Asia

- AE** United Arab Emirates
PERI (L.L.C.)
www.peri.ae
- AZ** Azerbaijan
PERI Representative Office
www.peri.com.tr
- HK** Hong Kong
PERI (Hong Kong) Limited
www.perihk.com
- ID** Indonesia
PT Beton Perkasa Wijaksana
www.betonperkasa.com
- IL** Israel
PERI F.E. Ltd.
www.peri.co.il
- IN** India
PERI (India) Pvt Ltd
www.peri.in
- IR** Iran
PERI Pars. Ltd.
www.peri.ir
- JO** Jordan
PERI GmbH – Jordan
www.peri.com
- JP** Japan
PERI Japan K.K.
www.peri.co.jp
- KR** Korea
PERI (Korea) Ltd.
www.perikorea.com
- KW** Kuwait
PERI Kuwait W.L.L.
www.peri.com.kw
- KZ** Kazakhstan
TOO PERI Kazakhstan
www.peri.kz
- LB** Lebanon
PERI Lebanon Sarl
lebanon@peri.de
- MY** Malaysia
PERI Formwork Malaysia Sdn. Bhd.
www.perimalaysia.com
- OM** Oman
PERI (L.L.C.)
www.peri.ae
- PH** Philippines
PERI-Asia Philippines, INC.
www.peri.com.ph
- QA** Qatar
PERI Qatar LLC
www.peri.qa
- SA** Saudi Arabia
PERI Saudi Arabia Ltd.
www.peri.com.sa
- SG** Singapore
PERI Asia Pte Ltd
www.periasia.com
- TH** Thailand
Peri (Thailand) Co., Ltd.
www.peri.co.th
- TR** Turkey
PERI Kalıp ve İskeleleri
www.peri.com.tr
- VN** Vietnam
PERI ASIA PTE LTD
www.peri.com.vn



PERI

**PERI GmbH
Formwork Scaffolding Engineering**

Rudolf-Diesel-Strasse 19
89264 Weissenhorn
Germany
Tel. +49 (0)7309.950-0
Fax +49 (0)7309.951-0
info@peri.com
www.peri.com

Oceania

AU Australia
PERI Australia Pty. Ltd.
www.periaus.com.au

DK Denmark
PERI Danmark A/S
www.peri.dk

IT Italy
PERI S.r.l.
www.peri.it

SE Sweden
PERI Sverige AB
www.peri.se

Europe

EE Estonia
PERI AS
www.peri.ee

LT Lithuania
PERI UAB
www.peri.lt

SI Slovenia
PERI oplate i skele d.o.o
www.peri.com.hr

AL Albania
PERI Kalıp ve İskeleleri
www.peri.com.tr

ES Spain
PERI S.A.U.
www.peri.es

LU Luxembourg
N.V. PERI S.A.
www.peri.lu

SK Slovakia
PERI spol. s. r.o.
www.peri.sk

AT Austria
PERI Ges.mbh
www.peri.at

FI Finland
PERI Suomi Ltd. Oy
www.perisuomi.fi

LV Latvia
PERI SIA
www.peri-latvija.lv

UA Ukraine
TOW PERI
www.peri.ua

BA Bosnia and Herzegovina
PERI oplate i skele d.o.o
www.peri.com.hr

FR France
PERI S.A.S.
www.peri.fr

NL Netherlands
PERI b.v.
www.peri.nl

BE Belgium
PERI N.V.
www.peri.be

GB United Kingdom
PERI Ltd.
www.peri.ltd.uk

NO Norway
PERI Norge AS
www.peri.no

BG Bulgaria
PERI Bulgaria EOOD
www.peri.bg

GR Greece
PERI Hellas Ltd.
www.perihellas.gr

PL Poland
PERI Polska Sp. z o.o.
www.peri.com.pl

BY Belorussia
IOOO PERI
www.peri.by

HR Croatia
PERI oplate i skele d.o.o.
www.peri.com.hr

PT Portugal
Pericofragens Lda.
www.peri.pt

CH Switzerland
PERI AG
www.peri.ch

HU Hungary
PERI Kft.
www.peri.hu

RO Romania
PERI România SRL
www.peri.ro

CZ Czech Republic
PERI spol. s r.o.
www.peri.cz

IR Ireland
Siteserv Access & Formwork
www.siteservaccess.ie

RS Serbia
PERI oplate d.o.o.
www.peri.rs

DE Germany
PERI GmbH
www.peri.de

IS Iceland
Armar ehf.
www.armor.is

RU Russia
OOO PERI
www.peri.ru

**The optimal System
for every Project and
every Requirement**



Wall Formwork



Column Formwork



Slab Formwork



Climbing Systems



Bridge Formwork



Tunnel Formwork



Shoring Systems



Construction Scaffold



Facade Scaffold



Industrial Scaffold



Access



Protection Scaffold



Safety Systems



System-Independent Accessories



Services



PERI GmbH
Formwork Scaffolding Engineering
 Rudolf-Diesel-Strasse 19
 89264 Weissenhorn
 Germany
 Tel. +49 (0)7309.950-0
 Fax +49 (0)7309.951-0
 info@peri.com
 www.peri.com